

NOTES:

- 1) 80 DUROMETER BLACK PVC (DENSITY 1.370 G/CM³)
- 2) 1.400" STAMPED STEEL (0.064 LB/FT)
- 3) LEATHER GRAIN TEXTURE

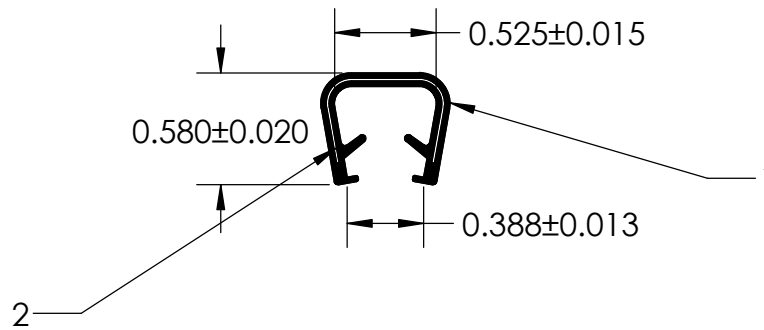
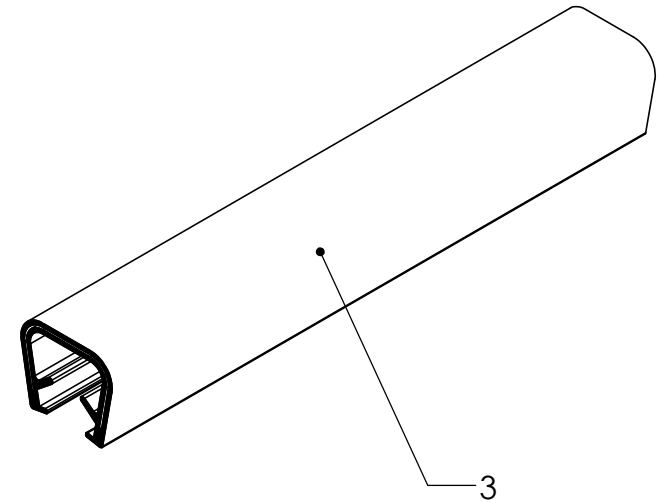

UNI-GRIP, INC.

9823 STATE ROUTE 53 N
UPPER SANDUSKY, OHIO 43351

PROPRIETARY AND CONFIDENTIAL:	UNLESS OTHERWISE SPECIFIED:
THE INFORMATION CONTAINED IN THIS DRAWING IS THE SOLE PROPERTY OF UNI-GRIP, INC. ANY REPRODUCTION IN PART OR AS A WHOLE WITHOUT THE WRITTEN PERMISSION OF UNI-GRIP, INC. IS PROHIBITED.	DIMENSIONS ARE IN INCHES TOLERANCES PER ARPM CLASS 3
	WEIGHT 0.128 LB/FT
	ASTM D1056 N/A
DOCUMENT CONTROL NUMBER UG-1-EN-001-FR-(111416)	ASTM D2000 N/A

TITLE: SD-1450		
SIZE A	DWG. NO. UG-1-ET-1400-FS-019	REV A